

CASE STUDY

Next Generation Threat Creation Using COTS Equipment

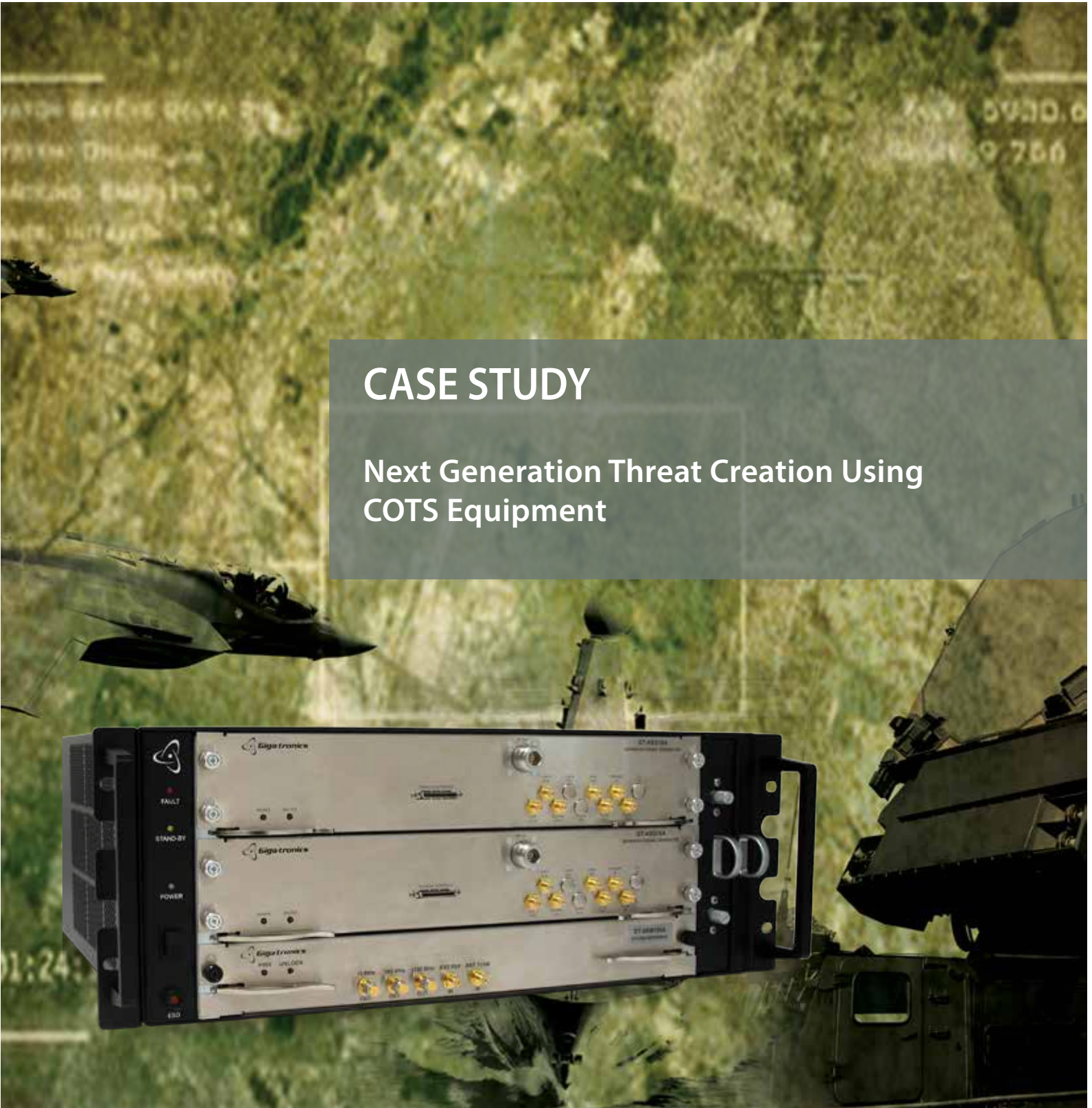

Author: Mark Elo, VP of Marketing
Published: June 11, 2014
Revision: A



Giga-tronics

Next Generation High Speed Signal Generator



Fueled by the global adoption and application of AESA technology, the science of Electronic Warfare is rapidly evolving. As an Engineer who needs to design test systems to emulate the latest threats, you are challenged to do this not only with COTS hardware, but with the requirement to generate a diverse set of threats and EW techniques, from legacy deployed radars to the most advanced high resolution SAR or Moving Target Indicator radars.

Cost and time constraints make it increasingly difficult to design a new test system for every program. For many good reasons, a versatile COTS based hardware platform strategy is often what is requested, however, the advanced nature of the signals required make it an almost impossible goal.

To develop new and legacy threats quickly and easily, a combination of high speed, multiple channel frequency synthesis and broadband up-conversion - as **now** provided in the new GT-ASG18A Advanced Signal Generator – used in conjunction with existing advanced Arbitrary Waveform Generators (AWG), give you the critical platform building blocks to create powerful new test systems, or even provide easy augmentation to existing systems. The GT-ASG18A, combined with an AWG, gives you the hardware to create almost any type of threat waveform set or technique you require.

To effectively discuss how to generate a suitable threat or EW technique, we first need to have some base definitions regarding the nature of the signal (Figure 1). When **Deterministic** signal creation is discussed it means we are going to create a waveform at a

specific instance in time. The speed of the update to the waveform is defined as the **Refresh Rate**, the time it takes the instrumentation to process the change is called the **Latency**, and the uncertainty in time of the change is the **Jitter**. Finally when we tune to different frequencies then back to the original we need to do that coherently. **Frequency Coherence** in this discussion is the ability to change from frequency to another then back to the first and continue in phase as if we had never tuned to another frequency.

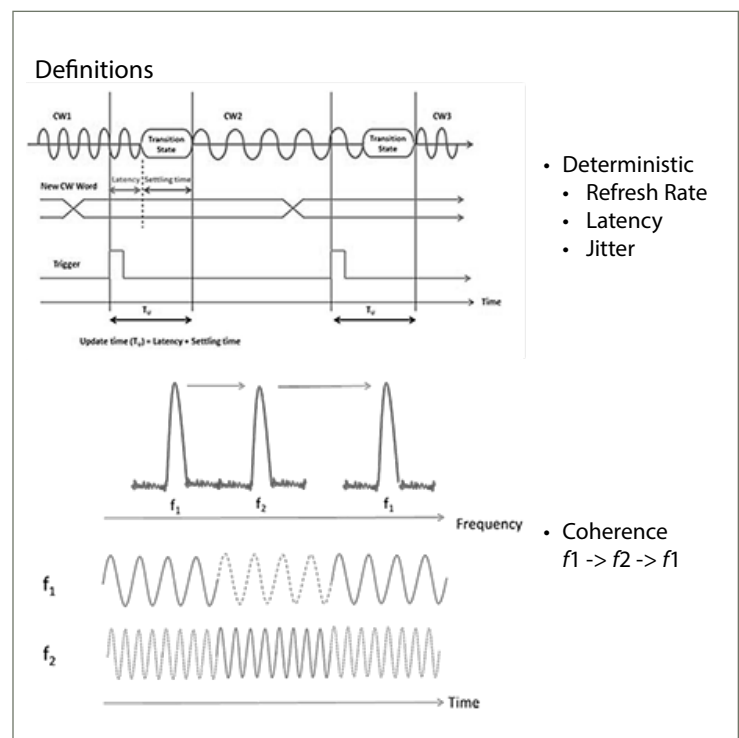

Figure 1.



Figure 2.

Figure 2 is a simplified block diagram of the key components of the system we need to create. The waveform memory is where all the pulses are stored. The waveforms are sequences of pulses stored as memory segments. The playback mechanism addresses the appropriate waveform memory segment, which in-turn plays them out to an IF. Finally a microwave up-converter transmits the waveforms at a frequency anywhere between 10 MHz and 18 GHz.

First let's examine different approaches for the IF, RF and Microwave sections.

Implementation of this part of the block diagram becomes challenging when you try to do this purely using COTS test equipment. For example, there are a number of COTS signal generators that you can feed an IF (or even feed with a baseband IQ signal), and up-convert to the required RF or Microwave bands. However, many of COTS signal generators use in-direct synthesis methods utilizing VCO/YIG architecture. This approach to synthesis while having a number of advantages for general test applications is less than ideal for EW or Radar as they are not very deterministic nor coherent.

There are also a number of COTS coherent deterministic signal generators available, which when used in conjunction with some connectorized

components give you the ability to create the up-converter. This is a reasonably good approach as the signal generators use the direct synthesis techniques. However, direct synthesis signal generators usually have a high part count and low MTBF. Furthermore, the components you would use to create the up-converter section are usually banded, so switching between bands incurs switching degradation times reducing the frequency agility of the system. Finally to create such a system means you will incur extra engineering costs of integrating a signal generator and the mixers, amplifiers, switches and filters required for the up-converter.

The waveform memory and playback mechanism can be addressed by using Arbitrary Waveform Generators, which can generate any type of signal required. They are, however, restricted in terms of signal fidelity and the maximum frequency, but in general provide a good solution for waveform storage and management.

As there are multiple 19 inch rack-mount solutions and modular PXI/VXI/AXIe solutions available, we should consider form factor. A requirement of such a test system would be the ability to scale the system at a later date for multi-channel operation, so a good approach would be to use modular components.



Today the COTS world of modular solutions offering advanced signal generation and AWG capability is mostly in two primary standards: PXIe and AXIe. Both use the PCIe bus, so the instrument appears to be on the bus of the control computer.

The PXI form factor has a number of VCO based signal generators and AWG's. Due to the smaller form factor of a PXI card making high performance instrumentation fit can be difficult. AXIe has much larger board areas and can dissipate much higher power per slot. This makes it ideal for higher performance instrumentation such as high speed synthesizers; wideband up and down converters, deep memory AWG's and high speed digitizers.

Figure 3, a typical AXIe chassis and backplane contains three zones: Power, Zone 1; PCIe, Local Bus and triggers Zone 2; and an optional Zone 3. In the Giga-tronics AXIe chassis, the Zone 3 Backplane contains a coherent sync bus, allowing multiple units to be synchronized phase coherently, making it ideal for

expanding performance to multiple microwave channels.

Earlier we examined different types of IF and up-converter approaches. Within the AXIe form factor



Figure 4.

there are a couple of options available. A banded frequency multiplication/up-converter system, and a fully coherent broadband deterministic signal generator with built in up-converter. The latter can switch a large instantaneous bandwidth quickly across a large frequency range, thus giving the ability to switch modulation on pulse signals quickly and deterministically across an entire spectrum from 10 MHz to 18.6 GHz. This product is the new GT-ASG18A Advanced Signal Generator. For this particular system the Giga-tronics unit is the best choice, due to its wide frequency operating range, coherence and deterministic behavior (Figure 4).

AXIe System Components

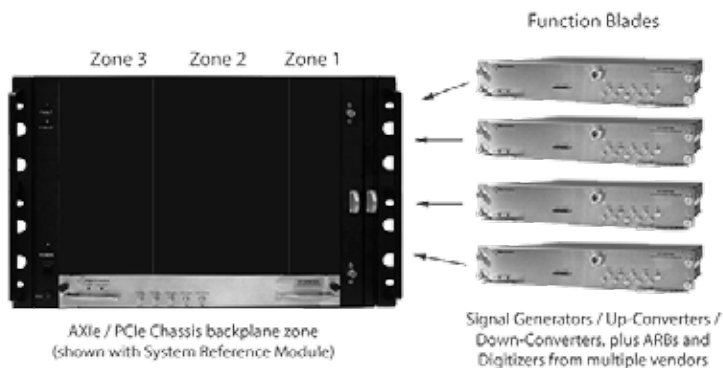

Figure 3.

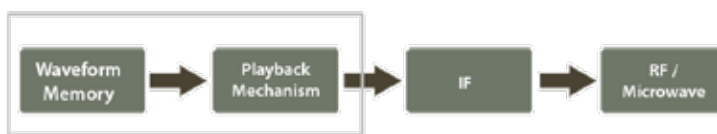

Figure 5.

For the Arbitrary Waveform Generator, we need good spectral purity with deterministic operation and the ability to access waveforms quickly. There are some considerations to examine. The choice of memory plays a big role in this type of application. Static



memory is usually faster to access, but you usually get less off it. With dynamic memory you can have a lot of storage but access times are usually much longer.

The sample rate is important as well. As we will want to produce a direct to IF signal, we'll need to sample at least 2.5 times the highest frequency we require to modulate or else we'll only have a couple of samples per maximum frequency period meaning that we will generate a lot of spurious signals.

We are going to compare two Arbitrary Waveform Generators – the Agilent 81180B, which samples at 4.6 GS/s and has 64 Ms of Static Ram and the Agilent M8190A which samples at 12 GS/s with 2 Gs of Dynamic Ram (Figure 6).

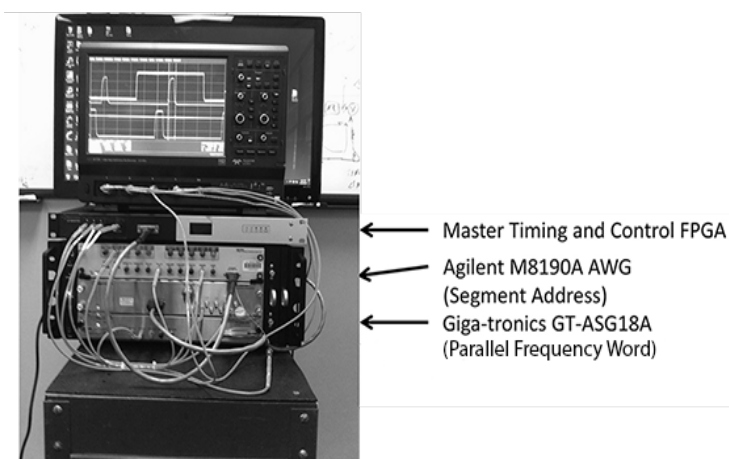

Figure 6.

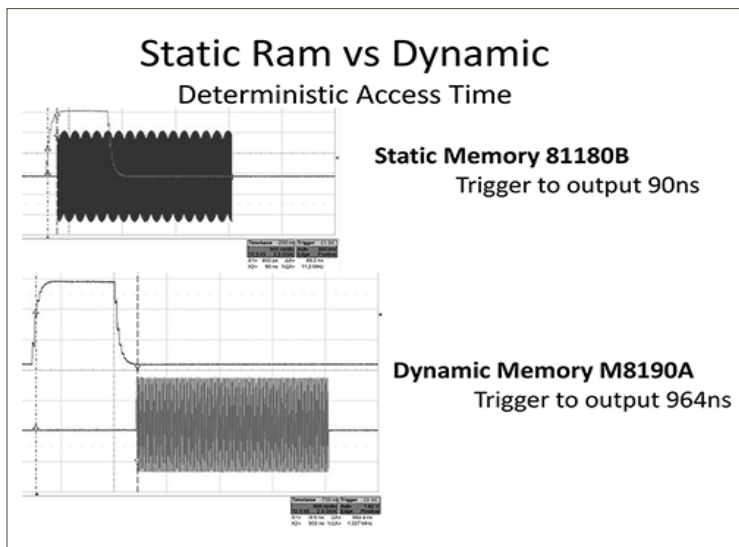

Figure 7.

In Figure 7 you can see the time between triggering the waveform and playback for the Static Memory AWG is 90 ns, while the dynamic memory AWG access time is around 900 ns. Other factors may cause time difference, but in general it is safe to assume Static RAM chips have access times in the 10 to 30 ns range, while dynamic RAM is usually much greater.



Harmonics

Harmonics are usually created by amplification in the output chain of the AWG. In Figure 8 you can see the harmonic performance of each AWG is about the same. Using the 1.2 GHz IF, linear frequency modulation (LFM) in excess of 900 MHz will cause degradation in the transmitted signal. This of course can be alleviated by moving the IF to 3.6 GHz, thus moving the harmonics out of band.

Clock and Quantization Spurs

In Figure 8 the anomalies of sampling so close to the Nyquist limit can be observed in both instruments and quantified in terms of Spurious Free Dynamic Range (SFDR). As the M8190 samples at a much higher rate the quantization spurs are much lower than with the 81180B.

Finally, we can further improve the spectral purity by using the reference in the Giga-tronics AXLe chassis. AXLe has a standard 100 MHz clock signal distributed on the back plane. The M8190A uses this signal as its reference. Using a Giga-tronics chassis, a lower jitter 100 MHz reference is provided by the chassis frequency reference.

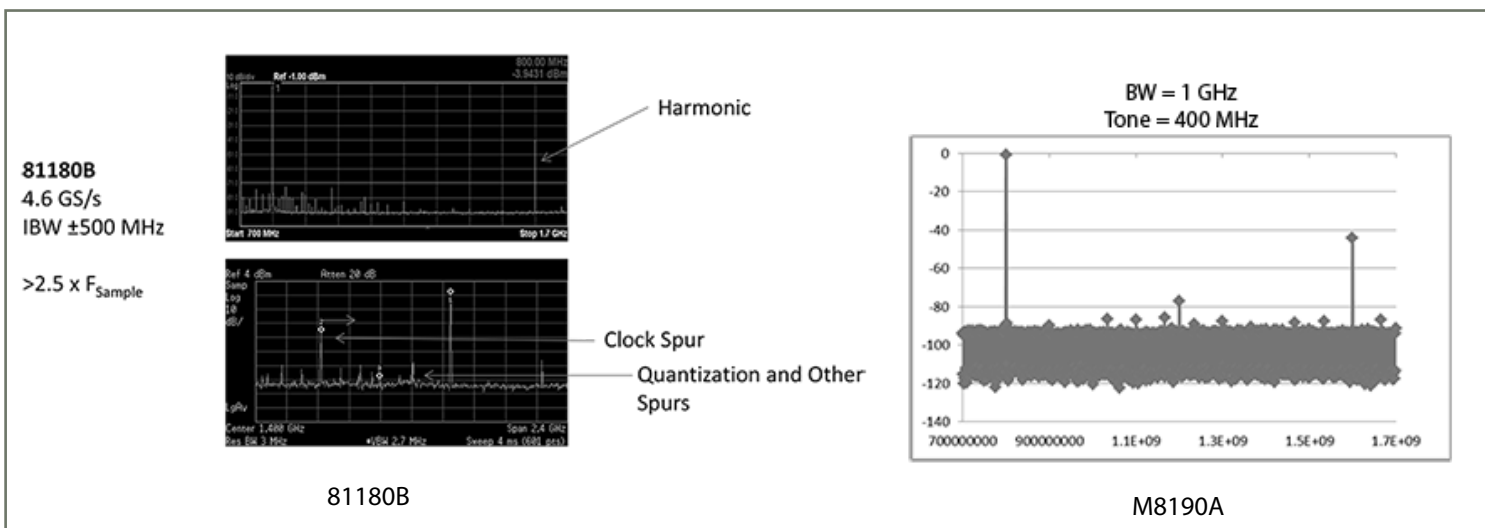

Figure 8.

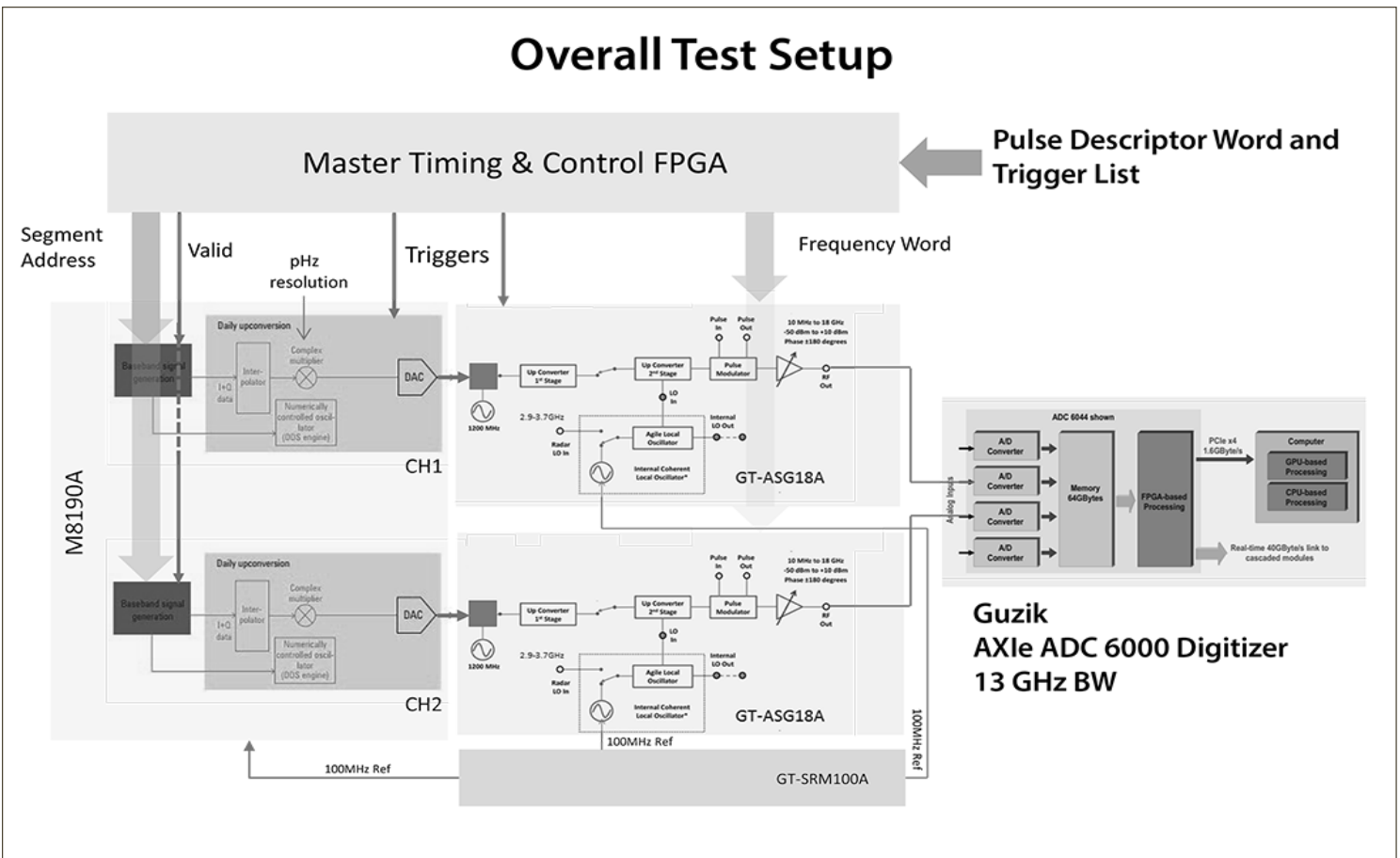

Figure 9.

Figure 9 is a two channel system created using a single two-channel Agilent M8190A AWG to feed two Giga-tronics GT-ASG18A Advanced Signal Generators. A prototype Vertex FPGA is used to

address the relevant waveforms and frequency words, then applying address valid and trigger lines to execute the waveform at the specific deterministic time.



Conclusion

The Giga-tronics GT-ASG18A used in conjunction with a high performance AWG can be used to produce any type of Radar signal or EW technique. When using AXIe modules, a very compact hardware system can be created. This can form the basis of a threat, radar or technique generation platform that can span multiple bands, with high speed coherent frequency switching with large instantaneous transmission bandwidths.

go-asg.gigatronics.com

Phone / Email

Toll free: 800.726.4442 (USA)

+1 925.328.4650 (International)

Email: asg-info@gigatronics.com